



**POSS** <sup>©</sup> | a modular  
furniture

# Let's start

POSSI is a modular furniture which functions as a kitchen. The core of POSSI is a flexible framework designed to enable the individual to form variable arrangements by easy assemblage.

POSSI's modularity allows for the system to be rearranged and upgraded with new features and technology anytime. Standard production methods and materials allow for simple repair locally wherever.

Simple and solid joints allow for the system to be easily taken apart, moved and rebuilt into initial or new arrangements. This organic structure makes a kitchen with long longevity. POSSI is malleable, made to fit your curves and your needs. Please play.

**01 frame**  
**02 cabinets +**  
**03 shelf layers**

**= 04 wall**  
**05 island**  
**06 shelf system**

# The POSSI system

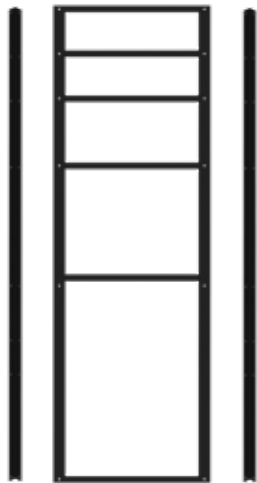

01

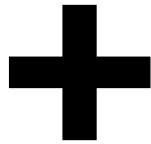

02

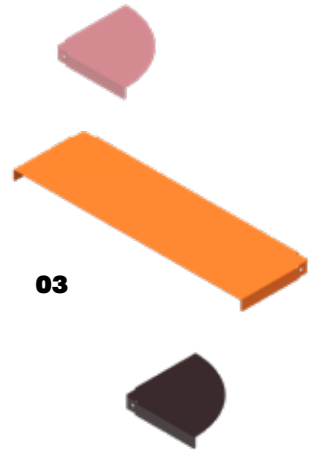
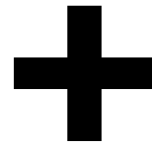

03



04

(or)



05

system



# modularity

POSSI's modularity allows for the system to be rearranged and upgraded with new features and technology anytime. It allows you to grow with your kitchen. You can start with a small or medium size and grow your POSSI over time into a large kitchen just according to your needs.

For an overview of all the modules and their available colours go to the components page. The collections propose pre-assumptions of configurations. You can always use them as a starter to configure your personal POSSI menu: reduce or add the juice out of it.

**a kitchen to hold on to**

# How it works

- 1 Get inspired and pre-configure your own POSSI.
- 2 Contact us with your ideas, measurements of your space and we jump on a call.
- 3 We will plan your POSSI for a small planning fee of 675DKK/90€ which disappears if you order a POSSI.
- 4 Adjust and confirm your planning.
- 5 Get your POSSI within 8-10 weeks after your order confirmation.

planning

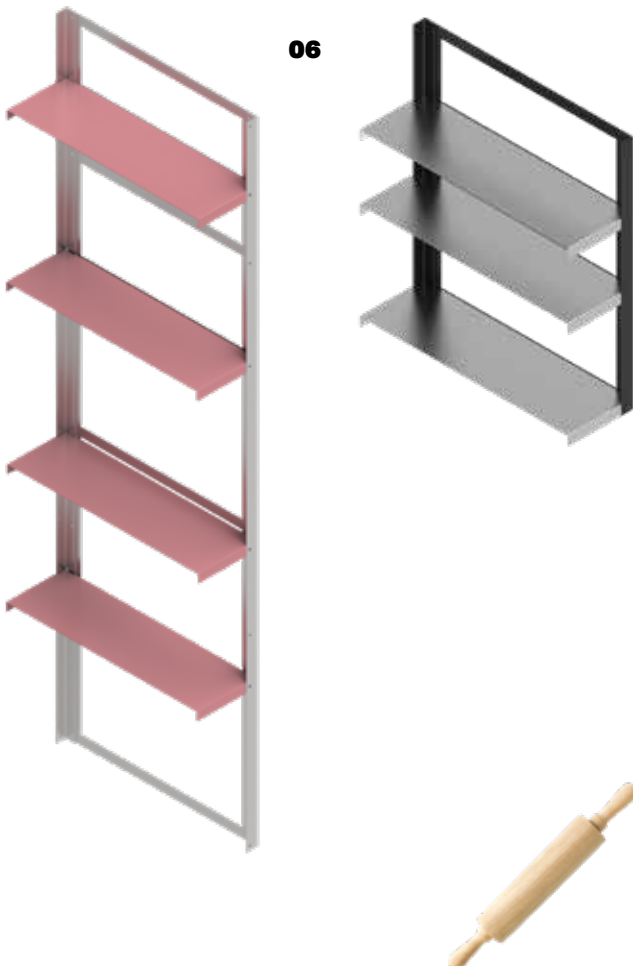

Meanwhile check our online shop for inspiration or for a POSSI wall shelf. [possi.kitchen/shop](https://possi.kitchen/shop)

**Configure your POSSI**

# 1 Configurations

**How do you want your POSSI?**

**a) Wall b) Island c) Shelf d) Wall + Island**

# 2 Components

**Have a look at the components page and choose all modules you need. Visit our collection page or instagram for inspirations.**

# 3 Color

**What color combination suits you best? Decide on a color for each module.**

## **3.1 cabinets**



**Volcanic Black**  
silk-matte

**Chalk White**  
silk-matte

**Horizon Blue**  
silk-matte

**Distant Blue**  
silk-matte

**Black Red**  
silk-matte

## **3.2 frame units**

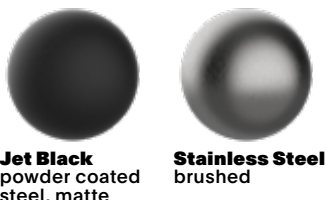

**Jet Black**  
powder coated  
steel, matte

**Stainless Steel**  
brushed

## **3.3 shelves**



**Bright Orange**  
powder coated  
steel, gloss

**Pink**  
powder coated  
steel, gloss

**Stainless Steel**  
brushed

**Bright Green**  
powder coated  
steel, gloss

**Black Red**  
powder coated  
steel, gloss

# 4 Worktop

**Our standard worktops come in the same color and finish as our cabinets. They are fairly heat-, water- and scratch resistant. The difference is only technical, but not visible.**

**Do you want to choose a highly heat- and scratch-resistant surface for your worktop?**

**If yes, these are available in black and white, for small additional cost. We work with mineral composite worktops aswell. Contact us for more info.**

# 5 Appliances

**Either you already have existing appliances or you want to purchase new ones.**

**Let us know, so we can make sure they are suitable for our system.**

**All standard appliances are possible.**

# 6 Send us your personal POSSI configuration.

**Ideally with measurements of your space or floor plan. We are happy to advise you in a personal call.**

types & ingredients





**components**  
all POSSI cabinets

**product standard**  
EN 14322

**colors**



**texture**  
silk-matte

**material class**  
melanin-faced chipboard

**raw materials**  
27% recycled wood  
32% by-products from the sawmill industry  
41% fresh resources



# high quality laminated wood



# POSSI wood parts

# Components

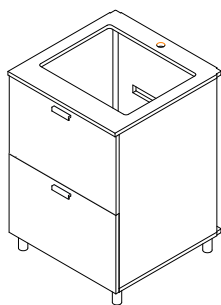

## sink module

930 × 647 × 650mm  
excl. appliances

worktop:  
scratch-resistant,  
anti-bacterial surface

front and body:  
laminated sustainably  
sourced chipboard



## optional BLANCO sink additions

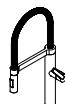
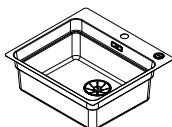

**9,375,00 DKK inclusive VAT**  
planning support\*

**1250,00 € inclusive VAT**  
planning support\*

**price on request**  
BLANCO sink additions  
BLANCO trash separation

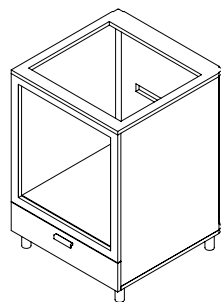
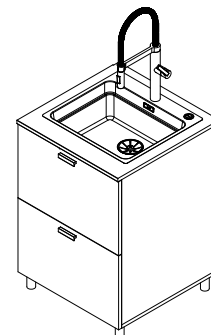

## oven & stove module

930 × 647 × 650mm  
incl. feet  
exclusive appliances

worktop:  
scratch-resistant,  
anti-bacterial surface

front and body:  
laminated sustainably  
sourced chipboard



## Note:

This module is made to fit  
all standard size  
appliances.

We recommend a Bora S  
Pure stove with an  
integrated cooker hood.

All drawers come in solid  
oak. 

**8.125,00 DKK inclusive VAT**  
planning support\*

**750,00 € inclusive VAT**  
planning support\*

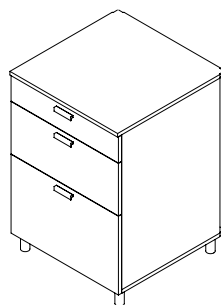

## storage module with drawers

930 × 647 × 650mm  
incl. feet

worktop:  
scratch-resistant,  
anti-bacterial surface

front and body:  
laminated sustainably  
sourced chipboard



## optional cutlery inlay in solid oak wood

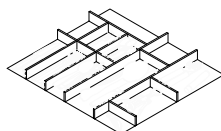

All drawers come in solid  
oak. 

**10.640,63 DKK inclusive VAT**  
planning support\*

**1.420,00 € inclusive VAT**  
planning support\*

**1.750,00 DKK inclusive VAT**  
integrated cutlery inlay

**235,00 € inclusive VAT**  
integrated cutlery inlay

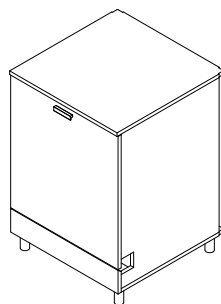

## dishwasher module

930 × 647 × 650mm  
excl. appliances  
incl. feet

worktop: scratch-resistant,  
anti-bacterial surface

front and body:  
laminated sustainably  
sourced chipboard



## Note:

the dishwasher module is  
made to fit all standard  
dishwasher appliances up  
to a height of 815mm

**5.000,00 DKK inclusive VAT**  
planning support\*

**669,00 € inclusive VAT**  
planning support\*

## Please note

\*To achieve the best planning result, start by placing the sink and oven module and check the connections.  
\*We will plan your POSSI for a small planning fee of 675DKK/90€ which disappears if you order a POSSI.

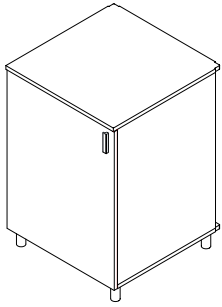

**storage module with door**

930 × 647 × 650mm  
incl. feet

worktop: scratch-resistant,  
anti-bacterial surface

front and body:  
laminated sustainably  
sourced chipboard



**Note:**

This module comes with 2  
inlays with an adjustable  
height.

**6.200,00 DKK inclusive VAT**  
planning support\*

**835,00 € inclusive VAT**  
planning support\*

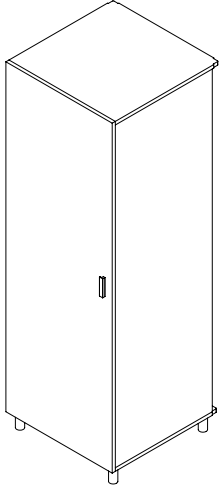

**integrated refrigerator  
or  
large storage module  
with layers**

1743 × 647 × 650mm  
excl. appliances  
incl. feet

front and body:  
laminated sustainably  
sourced chipboard



**Note:**

This module comes with  
inlays with an adjustable  
height.

Without inlays it is made to  
fit standard fridge  
appliances.

**6.750,00 DKK inclusive VAT**  
planning support\*

**900,00 € inclusive VAT**  
planning support\*

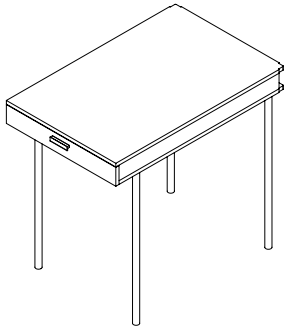

**worktable**

930 × 647 × 1000mm  
incl. feet and 1 drawer

worktop: scratch-resistant,  
anti-bacterial surface

front and body:  
laminated sustainably  
sourced chipboard



**Note:**

This module comes with a  
low drawer for cutting  
boards and other prep  
tools.

All drawers come in solid  
oak. 

**7.375,00 DKK inclusive VAT**  
planning support\*

**989,00 € inclusive VAT**  
planning support\*

(estimate)

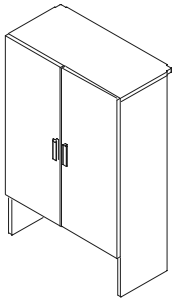

**top storage module**

800 × 647 × 310mm

laminated sustainably  
sourced chipboard



**5.250,00 DKK inclusive VAT**  
inclusive planning support\*

**700,00 € inclusive VAT**  
inclusive planning support\*

**wood parts**



**Volcanic Black**  
silk-matte



**Chalk White**  
silk-matte



**Horizon Blue**  
silk-matte



**Distant Blue**  
silk-matte



**Black Red**  
silk-matte

**modules & colours**

# POSSI metal parts

# Components

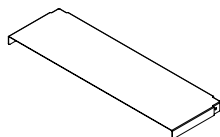

### shelf layer straight module

30 × 647 × 200mm  
powder coated steel  
or stainless steel



**625,00 DKK inclusive VAT**  
planning support\*



**562,50 DKK inclusive VAT**  
planning support\*

**85,00 € inclusive VAT**  
planning support\*

**75,00 € inclusive VAT**  
planning support\*

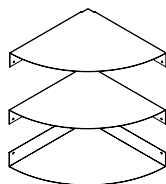

### shelf layer corner low modules set of 3

500 × 400 × 400mm  
powder coated steel  
or stainless steel



**875,00 DKK inclusive VAT**  
planning support\*



**119,00 € inclusive VAT**  
planning support\*

**812,50 DKK inclusive VAT**  
planning support\*

**109,00 € inclusive VAT**  
planning support\*



### shelf layer corner high module

30 × 200 × 200mm  
powder coated steel  
or stainless steel



**375,00 DKK inclusive VAT**  
planning support\*



**50,00 € inclusive VAT**  
planning support\*

**312,50 DKK inclusive VAT**  
planning support\*

**41,75 € inclusive VAT**  
planning support\*

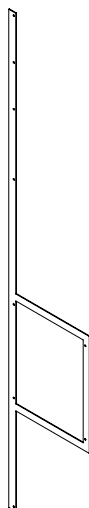

### frame unit corner

2130 × 400 × 3mm  
powder coated steel  
or stainless steel



**2.375,00 DKK inclusive VAT**  
planning support\*



**319,00 € inclusive VAT**  
planning support\*

**2.625,00 DKK inclusive VAT**  
planning support\*



**350,00 € inclusive VAT**  
planning support\*

### Please note

\*If the metal parts are part of your POSSI kitchen, then the planning runs under these conditions.

\*If you are interested in a shelving system, the planning is included.



**Bright Orange**  
powder coated  
steel, gloss



**Pink**  
powder coated  
steel, gloss



**Stainless  
Steel**  
brushed



**Bright Green**  
powder coated  
steel, gloss



**Black Red**  
powder coated  
steel, gloss

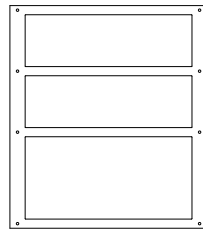
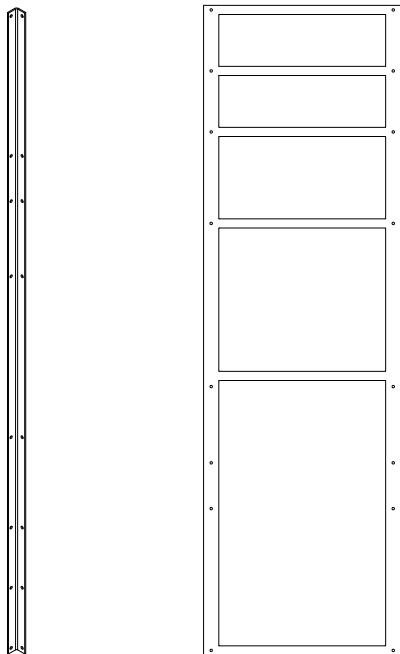

**frame unit small**

200 × 650 × 3mm  
powder coated steel  
or stainless steel



**1.375,00 DKK inclusive VAT** ●  
planning support\*

**185,00 € inclusive VAT**  
planning support\*

**1.625,00 DKK inclusive VAT** ●  
planning support\*

**219,00 € inclusive VAT**  
planning support\*

**L-Profil small**

213 × 650 × 35mm  
powder coated steel  
or stainless steel



**437,50 DKK inclusive VAT** ●  
planning support\*

**59,00 € inclusive VAT**  
planning support\*

**500,00 DKK inclusive VAT** ●  
planning support\*

**69,00 € inclusive VAT**  
planning support\*

**L-Profile standard**

2130 × 35 × 35mm  
powder coated steel  
or stainless steel



**875,00 DKK inclusive VAT** ●  
planning support\*

**119,00 € inclusive VAT**  
planning support\*

**1000,00 DKK inclusive VAT** ●  
planning support\*

**135,00 € inclusive VAT**  
planning support\*

**frame unit standard**

2130 × 647 × 3mm  
powder coated steel  
or stainless steel



**2.500,00 DKK inclusive VAT** ●  
planning support\*

**335,00 € inclusive VAT**  
planning support\*

**3.250,00 DKK inclusive VAT** ●  
planning support\*

**435,00 € inclusive VAT**  
planning support\*

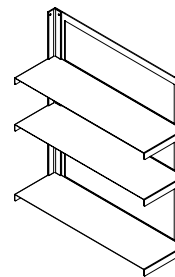
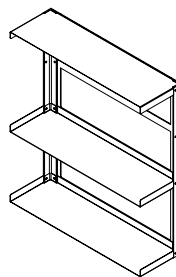
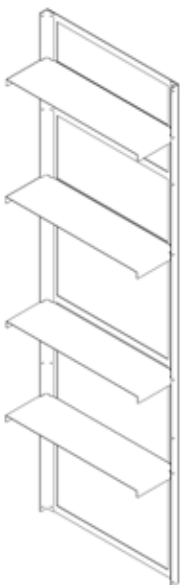

**POSSI wall shelf small**

730 × 647 × 200mm  
powder coated steel  
or stainless steel



planning support\*

**POSSI wall shelf standard**

2000 × 647 × 210mm  
powder coated steel  
or stainless steel



frame	shelf layer	small	standard
●	● ● ● ●	<b>4.125,00 DKK inclusive VAT</b> <b>550,00 € inclusive VAT</b>	<b>6.750,00 DKK inclusive VAT</b> <b>900,00 € inclusive VAT</b>
●	● ● ● ●	<b>4.500,00 DKK inclusive VAT</b> <b>600,00 € inclusive VAT</b>	<b>7.750,00 DKK inclusive VAT</b> <b>1035,00 € inclusive VAT</b>
●	●	<b>4.312,50 DKK inclusive VAT</b> <b>575,00 € inclusive VAT</b>	<b>7.500,00 DKK inclusive VAT</b> <b>525,00 € inclusive VAT</b>
●	●	<b>3.937,50 DKK inclusive VAT</b> <b>525,00 € inclusive VAT</b>	<b>6.500,00 DKK inclusive VAT</b> <b>870,00 € inclusive VAT</b>

# POSSI Ready-mades

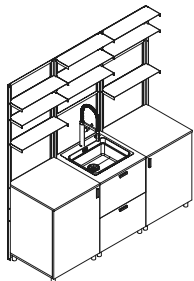

## price example for a small size kitchen

H × W × D 213 × 195 × 65cm  
 01 sink module excl. water tap, sink  
 & waste separation by Blanco  
 01 storage module w/ door  
 03 frame units  
 09 straight shelf layers

DKK price starting from  
**39.700,00 DKK incl. VAT**

€ price starting from  
**5.525,00€ incl. VAT**

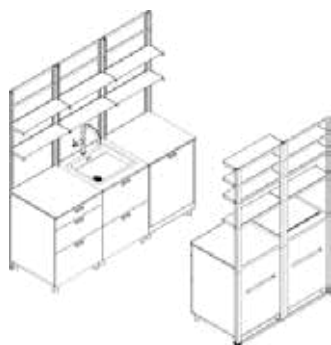

## price example for a medium size kitchen

H × W × D 213 × 325 × 65cm  
 01 oven/stove module  
 exclusive appliances  
 01 sink module excl. water tap, sink  
 & waste separation by Blanco  
 02 storage modules w/ drawers  
 01 dishwasher module excl.  
 dishwasher  
 05 frame units  
 13 straight shelf layers

DKK price starting from  
**76.750,00 DKK incl. VAT**

€ price starting from  
**10.250,00 € incl. VAT**

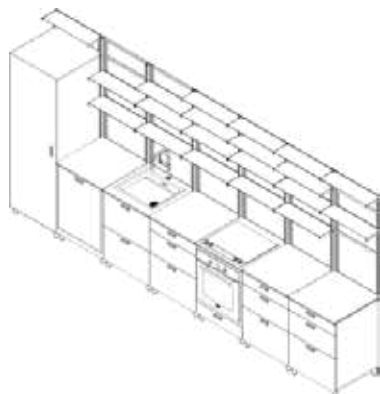

## price example for a large size kitchen

H × W × D 213 × 455 × 65cm  
 01 oven/stove module  
 exclusive appliances  
 01 sink module incl. water tap, sink & waste  
 separation by Blanco  
 02 storage w/ drawers modules  
 01 refrigerator module  
 exclusive fridge  
 01 dishwasher modules  
 exclusive dishwasher  
 07 frame units  
 20 straight shelf layers

DKK price starting from  
**109.125,00 DKK incl. VAT**

€ price starting from  
**14.550,00€ incl. VAT**

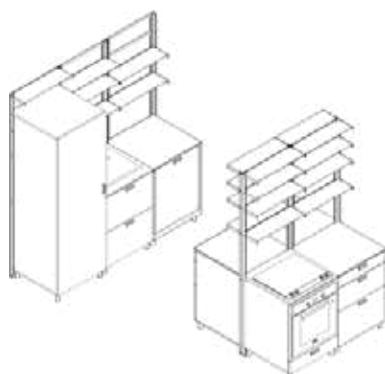

**don't  
put baby  
in the  
corner**

**growing from small to large**

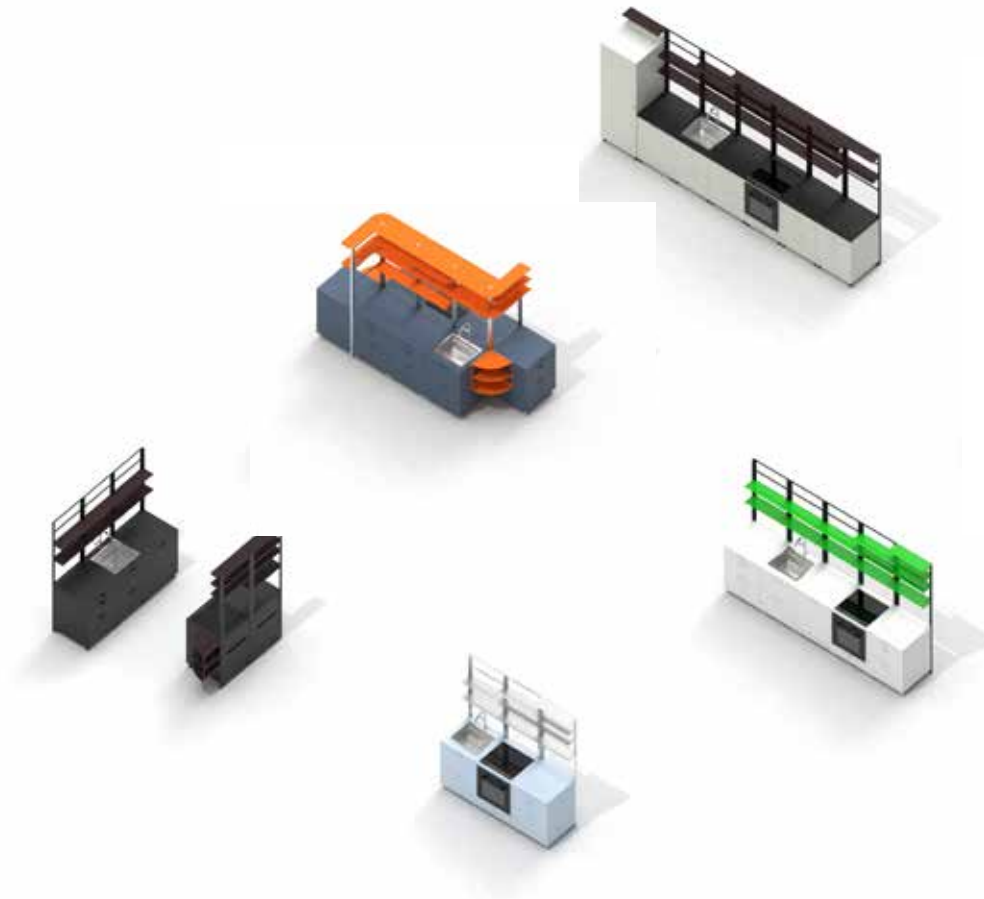
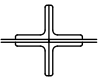
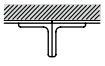

**ready-mades**

**Please play.**







**inspiration**